



Compound Gas Monitor Instruction Manual



Contents

1. Before use

- Check up----- (01)
- Introduction----- (02)
- Name of parts----- (03)
- Functions----- (04)
- Specifications----- (05)

2. Operation manual

- Main Menu Interface----- (06)
- Single Measurement Interface ----- (07)
- Multiple Measurement Interface----- (08)
- Record Checking Interface----- (08)
- Alarm Setting Interface----- (11)
- System settings interface----- (11)

3. Calibration Interface (ONLY FOR PROFESSIONAL)

- Sensor Calibration Selection Interface----- (12)
- Three Sensor Calibration Methods----- (13)

4. Others

- Charging function description----- (14)
- Warnings and Precautions----- (15)

1. Before use

Check up

Thanks for your purchasing our product, please check the following components after you unpacking the box. If there is any missing or wrong page manual, please contact the local dealer.

- Compound Gas Monitor (Contain Alligator clips) 1PCS
- Manual 1PCS
- Charger 1PCS
- Data line 1PCS
- Transparent trachea 1PCS
- Cover (with screws) 1PCS
- Packing box 1PCS

When you are ready to use this product, please make sure to read this manual first, and follow the relevant operations in usage so that you can fully understand the company's products and services while also avoiding unnecessary man-made damage or other accidents.

Introduction

Compound Gas Monitor adopts high-quality gas sensors, which displays safety and reliability with accurate measurement and stable performance. It has excellent sensitivity and repeatability, easy to use and maintain, and meets the requirements by safety monitoring in industrial site for high reliability of the equipment. The shell is made of high-strength engineering plastics and compound non-slip rubber, dust and explosion-proof, with high strength and smooth handfeel.

Compound Gas Monitor is widely used in petroleum, chemical, environmental protection, metallurgy, refining, gas transmission and distribution, biochemical medicine, agricultural research, etc.

This instrument conforms with the following procedures and calibration standards:

Gb3836.1—2010 Explosive Atmospheres Part 1: General Requirements for Equipment.

GB3836.4—2010 Explosive Atmospheres Part 4: Equipment with Intrinsically Safe "I" Protection.

GB15322.3—2003 Portable Combustible Gas Detectors Part 3: Portable Combustible Gas Detectors with a Measurement Range of (0~100) %LEL.

JJG693—2011 Verification Standards for Combustible Gas Detection Alarm.

JJG 365 — 2008 Verification Procedures for Electrochemical Oxygen Tester



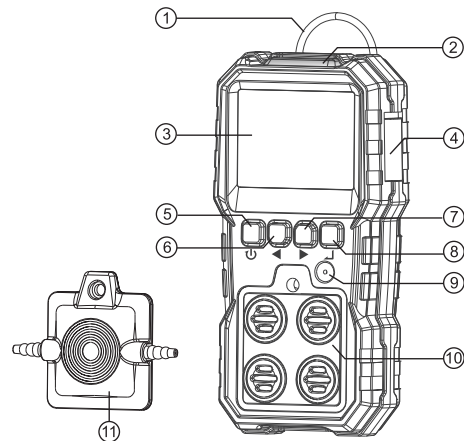

JJG695-2003 Verification Procedure for Hydrogen Sulfide Gas Detector

JJG915-2008 Verification Procedures for Carbon Monoxide Detection Alarm

Name of parts



(Figure 1)

1. Alligator clips on the back.
2. Transparent window for alarm indicator.
3. LCD display.
4. DC adaptor socket.
5.  Return button: long press on/off button, short press to return.
6.  Left button: left forward, upward, decrease.
7.  Right button: right forward, downward, increase.
8.  Confirm button: confirmation.
9. Buzzer alarm hole.
10. Gas sensing hole.
11. Gas calibration cover.

Functions

- Color-screen display, user-friendly interface.
- Bilingual choices: Chinese/English.
- Measurement of four gas concentrations: Combustible gas (LEL), Oxygen (O₂), Hydrogen sulfide (H₂S), Carbon monoxide (CO).
- Three alarm forms: sound/light/vibration.
- Data recording and review function, continuously record 120,000 data
- Charging function.

Specifications

Compound Gas Monitor range			
Measuring item	Unit	Range	Resolution
Combustible gas LEL	%LEL	0~100	0.1
Oxygen O ₂	%VOL	0~30	0.1
Hydrogen sulfide H ₂ S	μmol/mol	0~100	0.1
Carbon monoxide CO	μmol/mol	0~1000	1

Accuracy	≤±5%FS
Response time (90%)	Less than 30 seconds
Indication mode	LCD displays real-time data and system state, LED, sound, vibration indication alarm
Storage Conditions	Temperature:-10~55°C; Humidity:<85%RH
Operation Conditions	Temperature:-20~50°C; Humidity:<95%RH non-condensing
Working voltage	DC 3.7V (Lithium battery capacity 1800mAh)
Charging time	6~8h
Standby time	More than 8h on end (slightly change with working state)
Dimensions	71*153*49mm
Weight	218.7g With battery

2. Operation manual

Main Menu Interface

1. Long press on/off button (back button) for about 2 seconds. After powering on, the instrument enters into the countdown interface (for the sensor takes about 20 seconds to stabilize). After the countdown is over, the main menu screen will appear, as shown in the right figure.

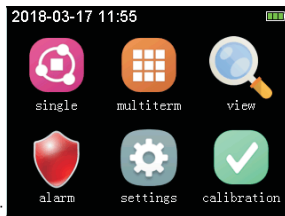

Main Menu Interface Display
(Figure 2)

2. The current date and time are displayed on the upper left corner. If the time is incorrect, enter the settings interface to set.
3. The battery level is displayed on the upper right corner. When the remaining power is low, the battery indicator will turn red. When the power level is detected to be too low, the instrument will start 10s countdown for automatic shutdown. The countdown second will be displayed on the left side of the battery indicator. After the countdown is over, the instrument will automatically shut down.
4. The main menu has 6 icons, namely, single measurement, multiple measurement, viewing records, alarm settings, system settings, calibration.
5. Functions of Buttons:
 - 1) Back button (⏪) : When the icon is selected, touch the icon and it will turn unselected, touch it again to go back to the first icon (unselected).
 - 2) Left/right button (⏪ / ⏩) : If an icon is not selected, touch the icon and it will become selected. Touch it again to select the next icon by pressing left/ right button.
 - 3) Confirm button (⏹) : If an icon is not selected, touch it once and the icon will turn selected; when the icon is selected, press confirm button to enter the corresponding interface of the icon.

Single Measurement Interface

1. This interface only displays single measurement values; the left side shows the maximum minimum, and average value, where the average value is the value measured in the last 4 minutes; the right side shows the high and low alarm values, and the middle shows real-time values.

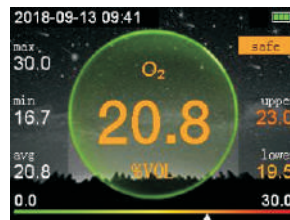

Single Measurement Interface Display
(Figure 3)

2. When checking oxygen concentration, if the concentration value is lower than the low alarm value, the instrument will trigger low alarm state. If the concentration is greater than the high alarm value, the instrument will trigger high alarm state; for the concentration of gas other than oxygen, if the concentration value is greater than the low alarm value, the instrument will trigger low alarm state. If the concentration is greater than the high alarm value, the instrument will trigger high alarm state.
3. In alarm state, Danger icon shows up; otherwise, Safety icon is displayed.
4. In the alarm state, if the alarm is triggered, an alarm will be issued and the alarm will be issued when the alarm is high. The alarm in high alarm state shows more urgency and faster frequency than that of low alarm state.
5. The alarm has three forms, light flashing alarm, sound alarm and vibration alarm, which can be turned on/off in the alarm setting.
6. The lower left corner of the screen shows the lower limit of the range, the lower right corner shows the upper limit of the range, the lowermost triangle indicates the color of real-time value.

- 1) Back button (⏪): back to main menu interface.
- 2) Left/right button (◀) / (▶): Switch measurement items (oxygen, carbonmonoxide, hydrogen sulfide, combustible gases).
- 3) Confirm button (⏵): No use.

Multiple Measurement Interface

1. The interface displays the real-time values of four items simultaneously, when the value exceeds the range, the number will flash; if alarm is on, an alarm will be triggered.

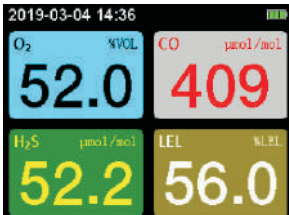

Multiple Measurement Interface Display (Figure 4)

2. Button function:

- 1) Back button (⏪): Back to main menu interface.
- 2) Left/right buttons (◀) / (▶): no use.
- 3) Confirm button (⏵): no use.

Record Checking Interface

1. After entering record checking interface, as shown in Figure 5.1. From left to right shows the number of each record, start time of record, number of record groups, record interval (seconds); each record can store 1019 pieces of data, and a total of 125 groups of records can be stored. When the stored data is full, the indicator "FULL" will appear at the top of screen.

The bottom shows the selected page number and total page number; which is page selection interface. Press "⏪" button to return to main menu, and press "◀" / (▶) button to choose previous or next page. After selecting page number, press "⏵" button to choose one record

and enter into record selection interface, as shown in Figure 5.2.

NO.	start record time	total	interval
1	2018.01.25 17:56:40	91	1
2	2018.01.25 17:58:37	203	1
3	2018.01.25 18:04:08	3	1
4	2018.01.25 18:04:29	1	1
5	2018.01.25 18:22:23	1019	1
6	2018.01.25 18:40:47	1019	1
7	2018.01.25 18:59:20	1019	1
8	2018.01.25 19:17:54	449	1

Page selection interface(Figure 5.1)

2. In record selection interface shown in Figure 5.2, press "⏪" button to return to page selection interface. Press "◀" / "▶" button to choose previous or next page. Press "⏵" button to check, delete, and choose which data to be delete, as shown in Figure 5.3.









NO.	start record time	total	interval
33	2018.01.27 11:51:44	1019	1
34	2018.01.27 12:11:42	1019	1
35	2018.01.27 12:32:05	1019	1
36	2018.01.27 12:52:16	1019	1
37	2018.01.27 13:12:24	1019	1
38	2018.01.27 13:32:53	1019	1
39	2018.01.27 13:53:05	997	1
40	2018.01.29 09:59:25	151	1

Record Checking Interface(Figure 5.2)

3. In record selection interface shown in Figure 5.3, press "⏪" button to return to record selection state; Press "◀" / "▶" button to check, delete, and choose which data to be deleted. Press "⏵" button to enter into interface for checking (Figure 5.4), deleting (Figure 5.5) and selected deletion (Figure 5.6).

NO.	start record time	total	interval
33	2018.01.27 11:51:44	1019	1
34	2018.01.27 12:11:42	1019	1
35	2018.01.27 12:32:05	1019	1
36	2018.01.27 12:52:16	1019	1
37	2018.01.27 13:12:24	1019	1
38	2018.01.27 13:32:53	1019	1
39	2018.01.27 13:53:05	997	1
40	2018.01.29 09:59:25	151	1

Checking delete interface(Figure 5.3)

4. The interface shown in Figure 5.4 is reviewing interface of recorded data, and the concentration value displayed on the right side is the value of data point pointed out by red line; 1/997 is displayed in the lower right corner, where 1 is the data point number and 997 is the group number of recorded data;  is an icon back to the start point, select the icon and press the " " button, the data point number will return to 1, and the red line goes back to the beginning;  is an icon for starting, after selecting it, the recorded data will automatically start reviewing, and the icon will turn into  , after selecting it, the automatic review will stop, the icon will turn into  ;  is an icon for moving leftwards, after selecting it and confirming, the red line will move to the left;  is an icon for moving rightwards, after selecting it, the red line will move to the right;  is an icon for fast moving leftwards;  is an icon for fast moving rightwards.

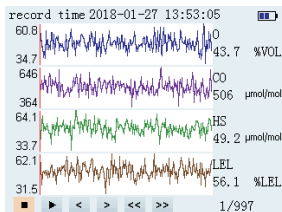

Checking Interface (Figure 5.4)

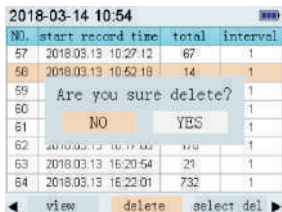

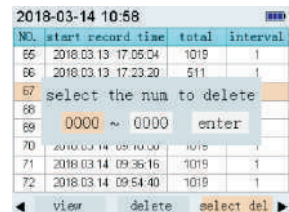

Deletion Interface (Figure 5.5)



Selected Deletion Interface (Figure 5.6)

5. Figure 5.5 shows deletion interface.

After selecting "Yes" and confirm, the recorded data will be deleted.

6. Figure 5.6 shows selected deletion interface. Pressing ""/" " button and " " button to input the serial number to be deleted, select

"OK" and press " " button. After that, the data within the range of serial number will be deleted.

Alarm Setting Interface

1. The alarm settings for each sensor can be set separately under this interface.
2. There are three alarm modes: light, sound, and vibration, which can be respectively set to be on or off. When the real-time measured value is greater than the high alarm value or low alarm value (for oxygen when it is lower than the low alarm value), the alarm which is set to be on will be triggered.

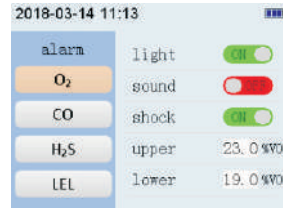

Alarm Setting Interface (Figure 6.1)

System settings interface

1. There are six setting items under the interface: language, date and time, auto storage, auto power off, backlight setting, and reset default.
2. The language can be Chinese or English; date and time can be set as year, month, day, hour, minute; if auto storage is on, the measured data will be automatically saved according to the set recording interval. If not, it will not be stored automatically; if the auto off is on, if there is no button operation within the set shutdown time, it will automatically shut down. If auto off is not on, it will not automatically shut down; in the backlight setting, there are three levels of backlight brightness; all parameters except for date and



System settings interface (Figure 7.1)

time (including calibration parameters) in the instrument can be restored to factory state;

3. Calibration Interface (ONLY FOR PROFESSIONAL)

Sensor Calibration Selection Interface

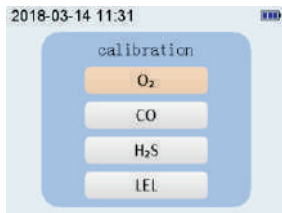

Sensor Calibration Selection Interface (Figure 8.1)

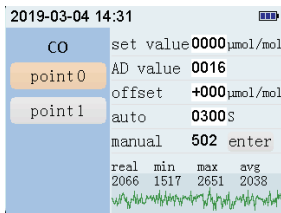

Sensor Calibration Interface (Figure 8.2)

1. First enter the sensor calibration selection interface shown in Figure 8.1. Press “◀”/“▶” button to select a sensor; then press “↵” to enter the single sensor calibration interface, as shown in Figure 8.2;
2. In the interface of Figure 8.2, the left side is the calibration point option, the right side is the calibration parameter corresponding to each calibration point, and the lower right area shows real-time value, minimum value, maximum value, average value and curve of the sensor signal; the concentration setting refers to setting the concentration value to be calibrated; calibration AD value refers to the signal value output by the sensor corresponding to the set concentration value; offset adjustment refers to the reading plus or minus the set deviation on the basis of the calibration point; timing calibration means that after the timing calibration is on, the countdown of the set timing starts. When the countdown reaches 0, the measured signal value is automatically stored in the calibration AD value. Manual calibration means that when the manual calibration is on, the real-time signal value is stored in the

calibration AD value by pressing “↵” button; the value between manual calibration icon and ENTER icon is the real-time measured concentration value.

Three Sensor Calibration Methods

1. there are three kinds of calibration methods:
 - 1) Input the calibration AD value directly: a. Set concentration value; b. Open to calibration gas which has set concentration value; c. Wait for the signal curve at the lower right of screen to be stable; d. After the signal is stable, input the real-time signal value to calibration AD value.
 - 2) Manual Calibration: a. Set concentration value; b. Open to the calibration gas which has set the concentration value; c. Wait for the signal curve at the lower right of screen to be stable; d. After the signal is stable, select manual calibration. Press “↵” button to confirm that the icon will be selected. Press “↵” button again and the real-time signal value will be added to the calibration AD value.
 - 3) Timing calibration: a. Set the concentration value; b. Open to the calibration gas with the set concentration value; c. Select timing calibration, press “↵” button, input the timing, then countdown starts, when the countdown reaches 0, the real-time signal value will be added to the calibration AD value.
 - 4) If the calibration is wrong, you can recalibrate or restore to factory settings in system settings.
2. When calibrating the zero point of carbon monoxide, hydrogen sulfide, and combustible gas, you can increase the calibration AD value by 5~9 to prevent the readings from appearing unrecoverable.

4. Others

Charging function description

When the power is insufficient or the voltage cannot be turned on due to undervoltage, please charge in time and charge it. During the charging process, the alarm light will flash and the meter will no longer detect the gas concentration and display the number of battery packs dynamically. When the number of battery packs is full and no longer changes dynamically, charging is completed. Then you can unplug the charger, the meter can be used normally. To speed up charging process, the screen will turn black after 10s of no operation. At this time, the charging interface can be resumed by pressing any button. When the power reaches 80% and there is no operation in 2 mins, the instrument will automatically shut down for charging.

Warnings and Precautions

Improper operation or environment may cause accidents.

1. The instrument is strictly prohibited from collision, falling from high places or violent vibration.
2. If there is gas of high concentration, the instrument may not work properly.
3. Please operate and use strictly in accordance with the instructions, otherwise it may result in inaccurate test results or damage to the instrument.
4. Do not store the instrument in the following environments:
 - a. Places that may have water or heavy dust.
 - b. The instrument must not be stored and used in environments that contain corrosive gases (such as salt or sulfur in high concentration, etc.).
 - c. Air with other gases or chemicals.

- d. Places of high temperature, high humidity or direct sunlight, including environments of too high and low temperatures, high humidity, electromagnetic fields, and strong sunlight.
5. Cleaning of the instrument's surface:
 - a. The window of the sensor must be kept clean. If it is dirty, the measurement will be inaccurate.
 - b. Please wipe it gently with a clean, soft cloth dampened with water (do not use alcohol, diluent, etc. to clean the case, especially for the LCD window.).
6. In order to ensure accuracy, the instrument should be calibrated regularly, and the period can not exceed one year.
7. If the instrument breaks down, please contact our professional personnel to repair it. Other people shall not change components and wiring.

 Warning: prohibit charging or disassembling batteries in an explosive environment.

TIPS: This device is equipped with rechargeable battery. If you receive the product and cannot start up, please connect with the adapter for charging before use.

Special Statement:

Our company shall hold no any responsibility resulting from using output from this product as an direct or indirect evidence. this company reserves the right of changing the product design and contents of instruction if changed the separate, notice isn't given.